

8ch Darlington Sink Driver

The ULN2803APG / AFWG Series are high-voltage, high-current darlington drivers comprised of eight NPN darlington pairs. All units feature integral clamp diodes for switching inductive loads. Applications include relay, hammer, lamp and display (LED) drivers. The suffix (G) appended to the part number represents a Lead (Pb)-Free product.

Features

- Output current (single output)
500 mA (Max.)
- High sustaining voltage output
50 V (Min.)
- Output clamp diodes
- Inputs compatible with various types of logic.
- Package Type-APG : DIP-18pin
- Package Type-AFWG : SOL-18pin

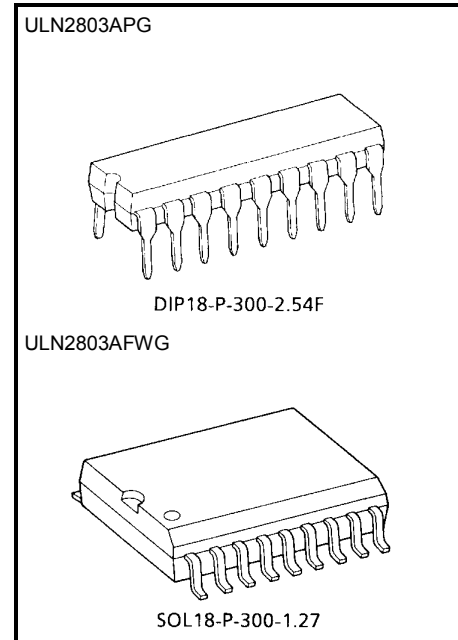

Weight
 DIP18-P-300-2.54F: 1.478 g (Typ.)
 SOL18-P-300-1.27 : 0.48 g (Typ.)

Type	Input Base Resistor	Designation
ULN2803APG / AFWG	2.7 kΩ	TTL, 5 V CMOS

Pin Connection (top view)

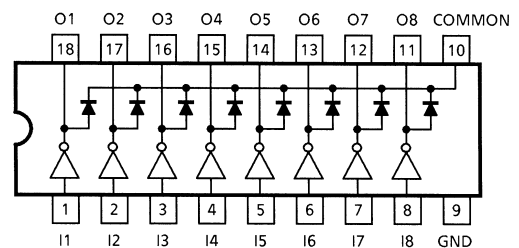

Schematics (each driver)

ULN2803APG / AFWG

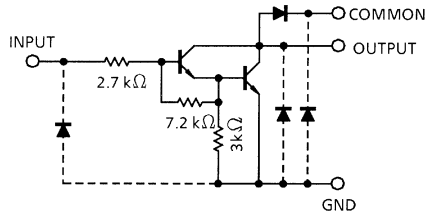

Note: The input and output parasitic diodes cannot be used as clamp diodes.

Absolute Maximum Ratings (Ta = 25°C)

Characteristic	Symbol	Rating	Unit
Output sustaining voltage	$V_{CE(SUS)}$	-0.5~50	V
Output current	I_{OUT}	500	mA / ch
Input voltage	V_{IN}	-0.5~30	V
Clamp diode reverse voltage	V_R	50	V
Clamp diode forward current	I_F	500	mA
Power dissipation	APG	1.47	W
	AFWG	0.92 / 1.31 (Note)	
Operating temperature	T_{opr}	-40~85	°C
Storage temperature	T_{stg}	-55~150	°C

Note: On Glass Epoxy PCB (75 × 114 × 1.6 mm Cu 20%)

Recommended Operating Conditions (Ta = -40~85°C)

Characteristic		Symbol	Test Condition	Min	Typ.	Max	Unit
Output sustaining voltage		V _{CE (SUS)}		0	—	50	V
Output current	APG	I _{OUT}	T _{pw} = 25 ms, Duty = 10%, 8 Circuits	0	—	347	mA / ch
			T _{pw} = 25 ms, Duty = 50%, 8 Circuits	0	—	123	
	AFWG		T _{pw} = 25 ms, Duty = 10%, 8 Circuits	0	—	268	
			T _{pw} = 25 ms, Duty = 50%, 8 Circuits	0	—	90	
Input voltage		V _{IN}		0	—	30	V
Input voltage (Output on)	ULN2803A	V _{IN (ON)}		3.5	—	30	V
	ULN2804A			8	—	30	
Clamp diode reverse voltage		V _R		—	—	50	V
Clamp diode forward current		I _F		—	—	400	mA
Power dissipation	APG	P _D	Ta = 85°C	—	—	0.76	W
	AFWG		Ta = 85°C (Note)	—	—	0.48	

Note: On Glass Epoxy PCB (75 × 114 × 1.6 mm Cu 20%)

Electrical Characteristics (Ta = 25°C)

Characteristic	Symbol	Test Cir-Cuit	Test Condition	Min	Typ.	Max	Unit
Output leakage current ULN2804A	I _{CEX}	1	V _{CE} = 50 V, Ta = 25°C	—	—	50	μA
			V _{CE} = 50 V, Ta = 85°C	—	—	100	
			V _{CE} = 50 V, V _{IN} = 1 V	—	—	500	
Collector-emitter saturation voltage	V _{CE (sat)}	2	I _{OUT} = 350 mA, I _{IN} = 500 μA	—	1.3	1.6	V
			I _{OUT} = 200 mA, I _{IN} = 350 μA	—	1.1	1.3	
			I _{OUT} = 100 mA, I _{IN} = 250 μA	—	0.9	1.1	
Input current ULN2803A ULN2804A	I _{IN (ON)}	2	V _{IN} = 3.85 V	—	0.93	1.35	mA
			V _{IN} = 5 V	—	0.35	0.5	
			V _{IN} = 12 V	—	1.0	1.45	
	I _{IN (OFF)}	4	I _{OUT} = 500 μA, Ta = 85°C	50	65	—	μA
Input voltage (Output on) ULN2803A ULN2804A	V _{IN (ON)}	5	V _{CE} = 2 V, I _{OUT} = 200 mA	—	—	2.4	V
			V _{CE} = 2 V, I _{OUT} = 250 mA	—	—	2.7	
			V _{CE} = 2 V, I _{OUT} = 300 mA	—	—	3.0	
			V _{CE} = 2 V, I _{OUT} = 125 mA	—	—	5.0	
			V _{CE} = 2 V, I _{OUT} = 200 mA	—	—	6.0	
			V _{CE} = 2 V, I _{OUT} = 275 mA	—	—	7.0	
			V _{CE} = 2 V, I _{OUT} = 350 mA	—	—	8.0	
DC current transfer ratio	h _{FE}	2	V _{CE} = 2 V, I _{OUT} = 350 mA	1000	—	—	
Clamp diode reverse current	I _R	6	Ta = 25°C (Note)	—	—	50	μA
			Ta = 85°C (Note)	—	—	100	
Clamp diode forward voltage	V _F	7	I _F = 350 mA	—	—	2.0	V
Input capacitance	C _{IN}	—		—	15	—	pF
Turn-on delay	t _{ON}	8	R _L = 125 Ω, V _{OUT} = 50 V	—	0.1	—	μs
Turn-off delay	t _{OFF}		R _L = 125 Ω, V _{OUT} = 50 V	—	0.2	—	

Note: V_R = V_R MAX.

Test Circuit

1. I_{CEX}

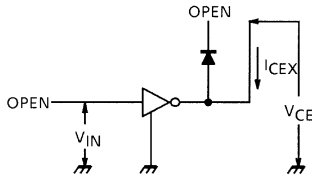

2. $V_{CE(sat)}$, h_{FE}

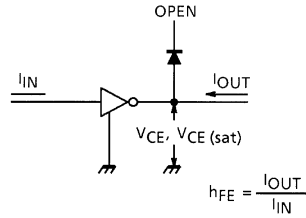

3. $I_{IN(ON)}$

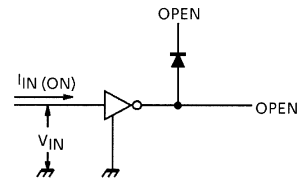

4. $I_{IN(OFF)}$

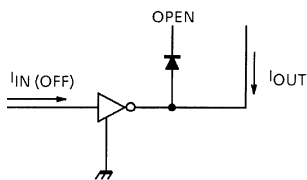

5. $V_{IN(ON)}$

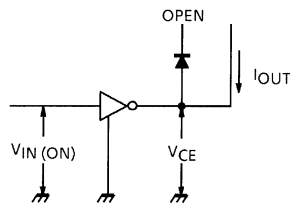

6. I_R

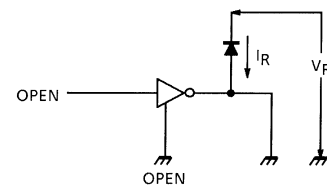

7. V_F

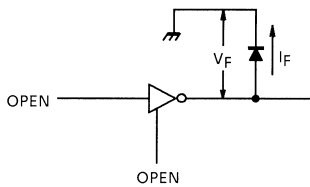

8. t_{ON} , t_{OFF}

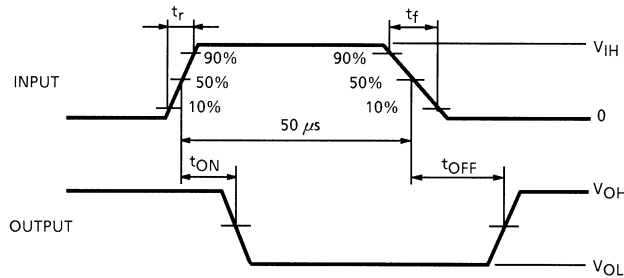
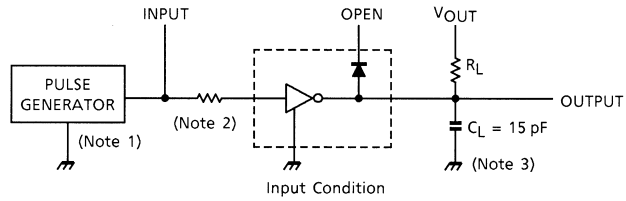

Note 1: Pulse Width 50 μ s, Duty Cycle 10%
Output Impedance 50 Ω , $t_r \leq 5$ ns, $t_f \leq 10$ ns

Note 2: See below.

Input Condition

Type Number	R1	V_{IH}
ULN2803A	0 Ω	3 V

Note 3: C_L includes probe and jig capacitance

Precautions for Using

This IC does not integrate protection circuits such as overcurrent and overvoltage protectors.

Thus, if excess current or voltage is applied to the IC, the IC may be damaged. Please design the IC so that excess current or voltage will not be applied to the IC.

Utmost care is necessary in the design of the output line, COMMON and GND line since IC may be destroyed due to short-circuit between outputs, air contamination fault, or fault by improper grounding.

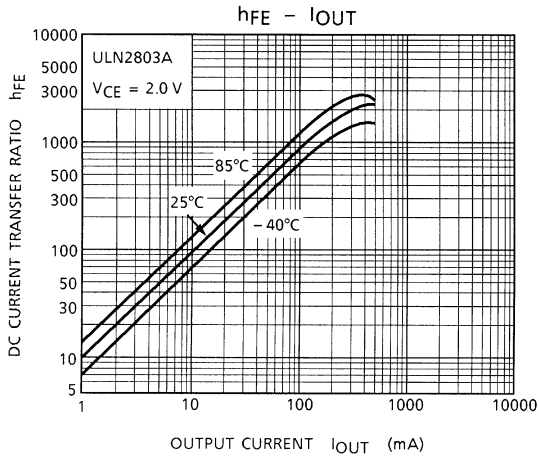
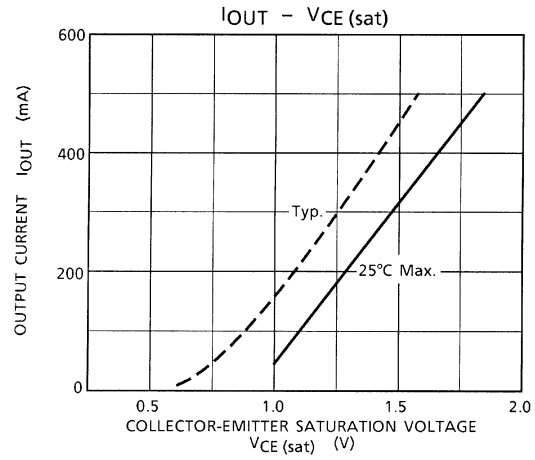
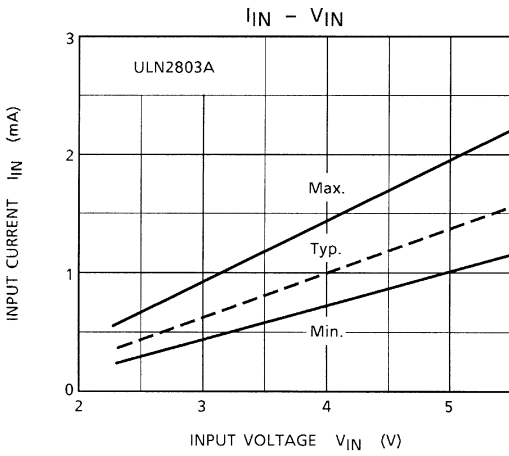

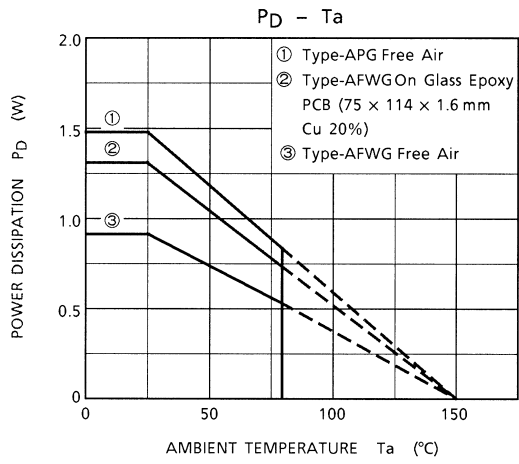

Package Dimensions

DIP18-P-300-2.54F

Unit: mm

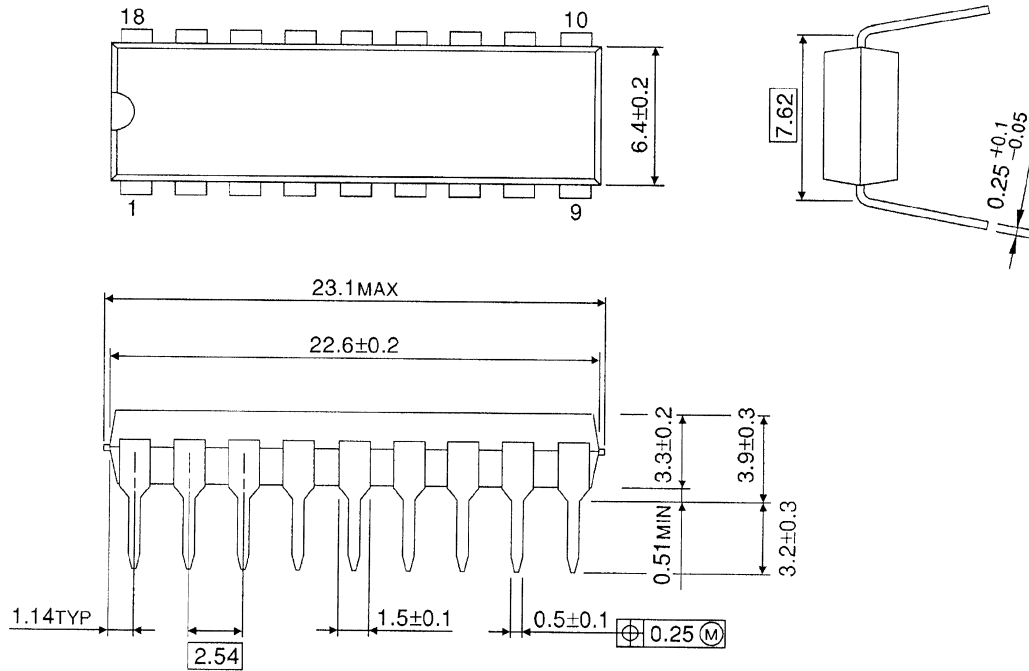

Weight: 1.478 g (Typ.)

Package Dimensions

SOL18-P-300-1.27

Unit: mm

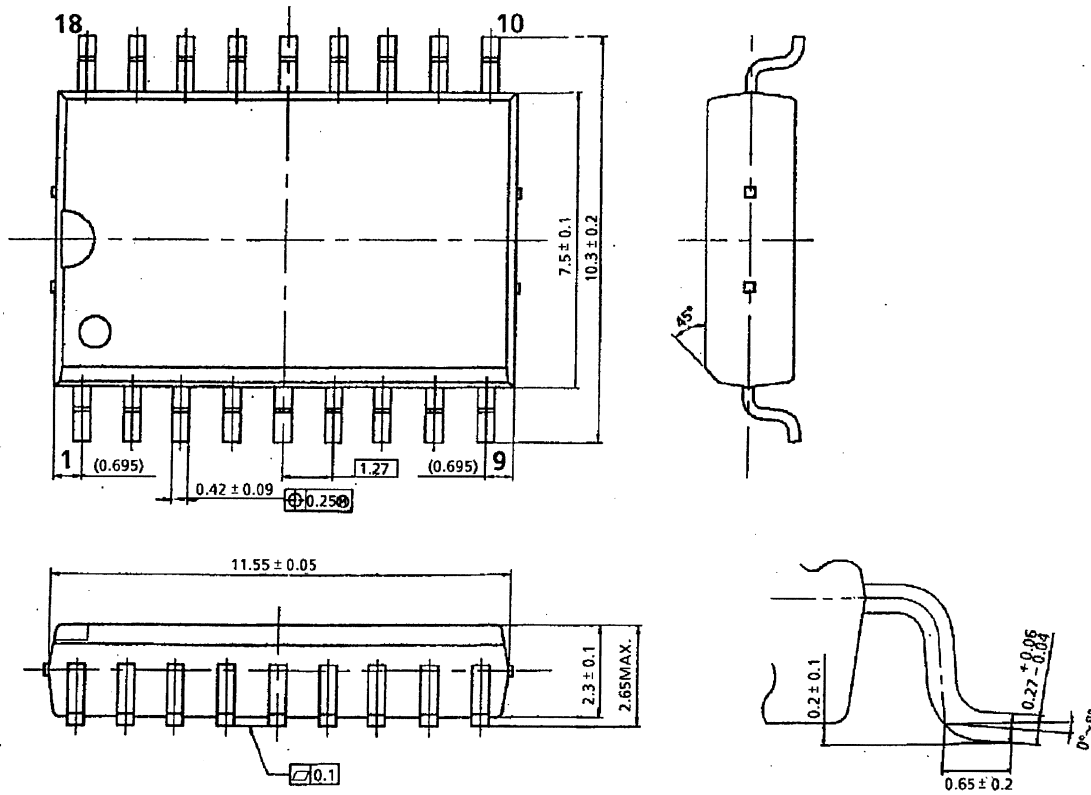

Weight: 0.48 g (Typ.)